

**TOM 4 CLASSIC**



 **boavista**  
solutions  
...THE WAY

# TOM 4 CLASSIC

## Conceito de Reabilitação Multifuncional

Graças aos seus múltiplos acessórios, esta cadeira adapta-se perfeitamente a qualquer necessidade de uma vida quotidiana: é basculante, encartável e reclinável.

A gama Tom 4 está disponível em 4 tamanhos. A Super Maxi está apta para utilizadores até 75 kg. Esta cadeira pode ser utilizada tanto em interiores como exteriores.



## Equipamento Standard

- Cadeira encartável
- Assento extraível, reversível e basculante
- Costas reclináveis
- Apoios de pés reguláveis em ângulo e altura
- Barra de empurrar regulável em altura
- Rodas dianteiras giratórias
- Todas as rodas são maciças
- Estofos extraíveis e laváveis
- Cumpre os requisitos da norma EN7176/19 capacitando-a para o transporte em veículos
- Cinto de 2 pontos Bodypoint Tam. XS ou S



# TOM 4 CLASSIC

## Uma grande ajuda terapêutica

Todos os tamanhos estão disponíveis com um ampla gama de acessórios. Toda a gama cumpre com todos os requisitos higiénicos, técnicos e de segurança.



• Com chassi de interior e tabuleiro



• Extensão de proteção lateral



• Capota

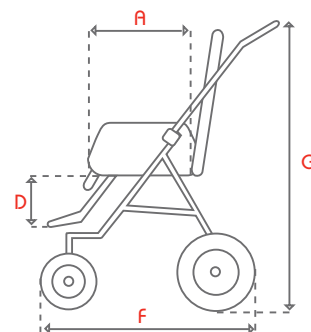
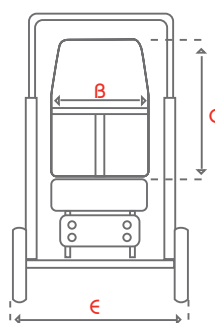

R34



R35



R36



R37

Tamanho	MINI	STANDARD	MAXI	SUPER MAXI
A- Profundidade do assento	24-31	27-35	32-40	32-43
B- Largura do assento	26-30	24-28-34	28-32-38	34-38-42
C- Altura das costas	44-61	51-65	56-67	57-67
D- Altura dos patins	14-28	20-35	24-40	24-40
E- largura Total	61	61	65	70
F- Comprimento total	86	86	92	110
G- Altura frontal (com barra frontal)	101-115	101-115	103-118	103-118
Regulação ângulo assento	+/-27°	+/-27°	+/-25°	+/-25°
Regulação do ângulo costas	0°/180°	0°/180°	0°/160°	0°/160°
Carga Máxima	35 kg.	35 kg.	50 kg.	75 kg.
Peso	17.5 kg.	18.5 kg.	21 kg.	24 kg.
Travão	de pé	de pé	de pé	de pé
Comprimento total da cadeira encartada	93	93	96	96
Largura total da cadeira encartada	61	61	65	70
Altura total da cadeira encartada	55	55	63	66



# TOM 4 CLASSIC

## ACESSÓRIOS

Suporte de cabeça  
(par)



Apoio de cabeça em  
forma de "U"

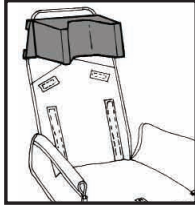

Suporte Laterais Tronco  
(par)



Suporte Lateral



Cinto Abdominal

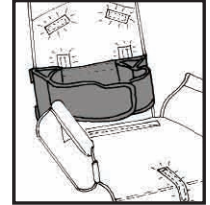

Taco abdutor



Calção abdutor



Cinto pélvico



Cinto de 4 pontos



Cinto de 5 pontos

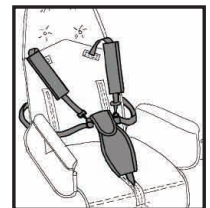

Colete de fixação



Arnes



Fita para pés



Apoios de pés curtos  
(só para tom 4 Mini)

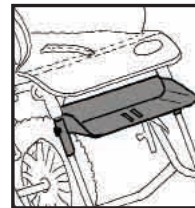

Tabuleiro



Chassi de interiores



Capota de sol



Extensão protector  
lateral

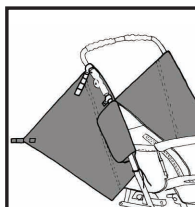

Saco de Inverno

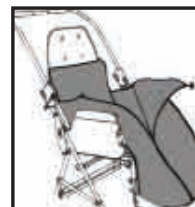

Capa Impermeável  
(só com a capota)



Redutor de assento  
acolchoado (par)



Cesta HD  
(tela de alta densidade)



Cesto de Tela



Bolsa



Protectores de barra  
(par)



em parceria com:

 rehagirona

BOAVISTA SOLUTIONS, LDA  
Rua Engº Ezequiel de Campos, 541-2º . Zona Industrial do Porto  
4100-233 Porto Portugal  
Tel. +351 22 615 11 50 . Fax. +351 22 615 11 52  
info@boavistasolutions.eu www.boavistasolutions.eu

 patron